



Comm de Nom

Boutique Luxury Wallpapers

Hanging Instructions

These fine wall-coverings offer a softer, more refined look and feel than traditional papers and are superior in strength, making them the perfect choice for the DIY homeowner. The added strength resists accidental tears during installation and makes removal easier.

INSPECTION

Inspect every roll to ensure that all rolls are in good condition, with no variations in shade, and that no other faults are present. We cannot accept liability for defects that are apparent at the time of hanging, nor can we be responsible for any consequential loss. After hanging 2 or 3 lengths/panels we strongly recommend that you carefully inspect the results. Note: Product does not change appearance from wet to dry.

PREPARATION

Preparing a wall for wallpaper is like laying good foundations for a beautiful home. It needs to be done methodically, and thoroughly. So find the perfectionist within you and follow these steps, as required:

1. You want the wall as clean as possible, so remove all traces of dirt, old wallpaper and flaking paint. If required, using a suitable filler, even out cracks and irregularities to achieve a satisfyingly smooth surface.
2. Sand and prime the filled areas - priming will seal the filler and stop it from drying at a different rate. Unprimed filler can cause the paper to bubble as it draws all the

moisture from the paste. Once you've smoothed, filled, and sanded your wall, make sure all surfaces are clean and dry.

3. To achieve perfect edges, before you hang your wallpaper, you may need to paint the wall a similar color to the wallpaper you are applying to ensure that the background doesn't show through at the seams where the edges of wallpaper meet.
4. Do not hang wallpaper on new plaster or walls that are absorbent, such as concrete. Walls must be primed in advance to make sure that the wall is sealed and the wallpaper paste is not absorbed into the surface.

'Paste the Wall' wallpapers use a special backing containing 'non-woven' or polyester fibers. This means that the wall-covering is dimensionally stable and doesn't expand when wet. This allows the paper to be hung dry from the roll, reducing the installation time by around half. No paste table is needed, there's no soaking time, and it's easier to cut around light switches and sockets, because the paper is dry.

Paste the Wall's dimensional stability also means there is less risk of bubbling, creasing or edge curl.

Choosing a suitable wallpaper adhesive will ensure your wallpaper installation goes smoothly.

We recommend the following tub adhesives

- Roman PRO-838 HEAVY DUTY or
- Roman 234 PREMIUM GRADE.

Both adhesives are easy to use, provide excellent 'wet' tack, good slip for positioning, and clean up easily with water.

Step 1

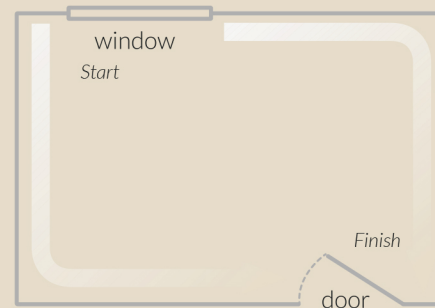

When installing wallpaper a good tip is to always work away from the main source of light and finish in the least conspicuous corner.

First, chop the header off your roll. You can use this as a template to measure the width required for your drops.

Step 2

Using the header, measure this amount out from the corner (in the direction you are going) minus half an inch.

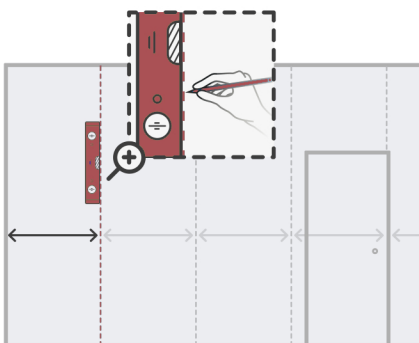

Put a mark close to the ceiling at this point. This is where you start your spirit-level or plumb-line from and will allow half an inch overlap around the corner. Mark down the plumb-line every 11-15". This will give you a good vertical line to hang your first length to. USE PENCIL ONLY.

Step 3

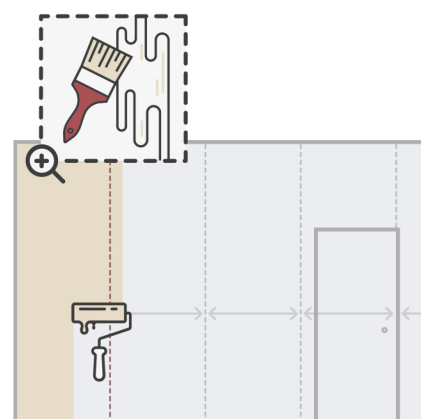

Our wallpapers are made using a non-woven base, that means you apply the adhesive directly to the wall. Start by pasting an area sufficient enough to cover just over one drop width at a time.

Use a paintbrush to cut-in around the areas too tight for the roller. (Such as at the ceiling line, corners, and along baseboards and trim).

Step 4

When moving the wallpaper to the wall, fold the length together in the middle with the pattern inwards in order to avoid getting adhesive on the front of the wallpaper.

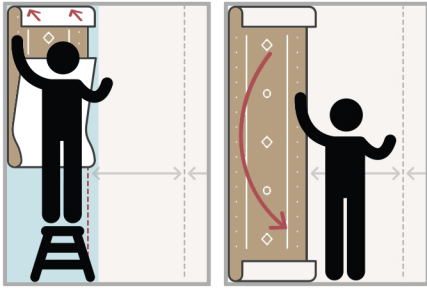

Attach the top of the length to the wall at the preferred height and in the correct position before letting go of the rest. Align the top and bottom of the first length before “smoothing down” the wallpaper.

If you make a mistake, remove the length and start over. Apply more adhesive if the first coat has dried.

Step 5

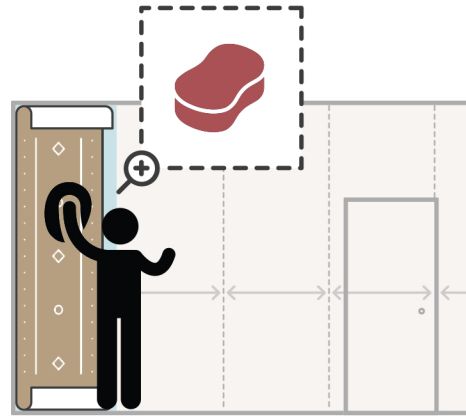

To get rid of air pockets, use a clean roller, sponge or brush, taking care not to squeeze out the paste between the joins and ensure the paste does not get onto the smoothing roller or sponge.

Work from the ceiling to the floor and from the middle to the edges. Do not use any hard tool that would damage the surface.

Step 6

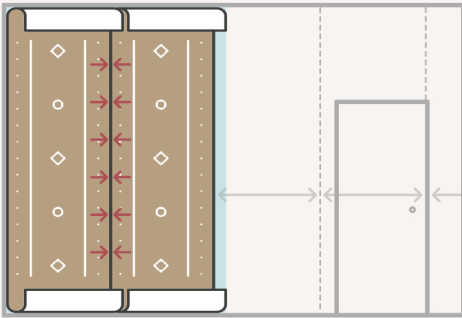

Butt join the lengths of wallpaper together, matching up the edges. Ensure that the lengths are properly positioned, that the pattern is matching and there is no surface visible at the joints.

It is important that adhesive be applied right out to the edges to ensure the lengths adhere to the wall properly.

Step 7

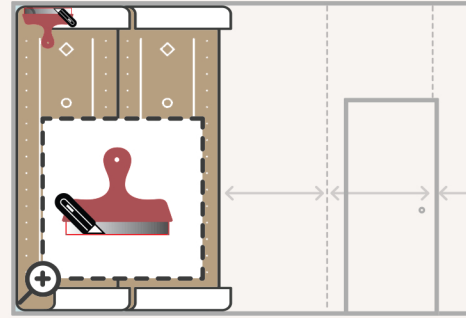

When you're happy with the position, using a straight edge, trim the excess wallpaper at the top and bottom of the wall. Use a sharp snap off blade knife. Push the paper into the ceiling line and skirting.

Replace the blade often, as a dull blade can easily tear the wallpaper.

Step 8

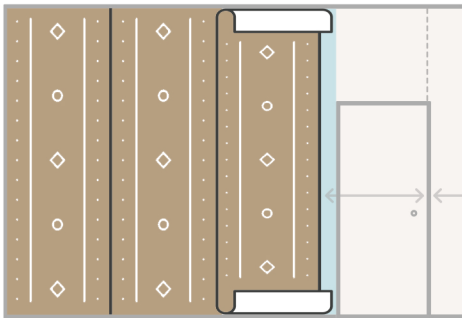

Continue in this manner across the wall until it is finished.

Our papers have a traditional matte finish, so you can wipe off any shiny marks from the paste with a soft, damp cloth.

Use a soft clean dry cloth to remove residual water after cleaning to prevent marking.

To get the best out of your wallpaper, please take the following points into consideration.

1. While our papers can be hung in bathrooms and kitchens, they are not suitable for high humidity areas. If planning to paper a humid room, please ensure the room is well ventilated, the paper is installed using a mold & mildew inhibiting paste, and avoid any direct contact with water.
2. Local conditions will differ from room to room depending on size, extraction, and general humidity, all of which result in varying levels of condensation. As such, we cannot guarantee our papers' suitability across all situations.
3. Air the room! Remember to never shut up a room of newly-hung wallpaper, but leave to air and maintain a normal room temperature to ensure the wallpaper dries properly. The room and wall should be kept at a minimum of 64°F

POTENTIAL INSTALLATION ISSUES

1. Raised edges and blistering. These common problems are not due to the wallpaper, but rather to the amount of adhesive used. Be sure to apply a generous even coat of paste to the wall. This also allows the paper to slip, making installation a little easier.
2. Seams become visible. It's generally a function of not providing sufficient pressure/smoothing along the seams, during the installation. It's also important **not to 'stretch' the wallpaper in order to butt the seams**. Rather than working the wallpaper too hard, it's best to remove the panel from the wall and reapply in the correct position.

CLEANING & CARE

All wallpapers are washable using a mild soap that does not contain detergent. Rinse with clear clean water. Stains caused by grease and oil may not necessarily be removed. Do not use abrasives. Do not rub.

The information given here or any other technical advice, whether verbal or in writing or by way of trial – is for guidance only and is given in good faith but without warranty, since the skill of application and site conditions are beyond our control.